

DEBUG IN HIGH DEFINITION



HDO8000A

350 MHz – 1 GHz
Oscilloscopes



The Only 8 Channel,
12 Bit, 1 GHz Oscilloscope

Lowest Noise and
Unbelievably Powerful

HD4096 Technology

Superior User Experience

Powerful, Deep Toolbox

Exceptional Serial Data Tools

The HDO8000A with HD4096 Technology provides exceptional signal fidelity with 12-bit resolution and a superior oscilloscope experience to deliver faster time to insight.

DEBUG IN HIGH DEFINITION

High Definition Oscilloscopes with HD Technology have a variety of benefits that allow the user to debug in high definition. Waveforms displayed by High Definition Oscilloscopes are cleaner and crisper. More signal details can be seen and measured; these measurements are made with unmatched precision resulting in better test results and shorter debug time.



Experience HD4096 accuracy, detail, and precision and never use an 8-bit oscilloscope again. Whether the application is general-purpose design and debug, high-precision analog, power electronics, automotive electronics, mechatronics, or other specialized applications, the HD4096 technology provides unsurpassed confidence and measurement capabilities.

Clean, Crisp Waveforms

When compared to waveforms acquired and displayed using conventional 8-bit oscilloscopes, waveforms captured with HD4096 12-bit technology are dramatically crisper and cleaner, and are displayed more accurately.

More Signal Details

16x more resolution provides more signal detail. This is especially helpful for wide dynamic range signals in which a full-scale signal must be acquired while at the same time very small amplitude signal details must be analyzed.

Unmatched Measurement Precision

HD4096 technology delivers measurement precision several times better than conventional 8-bit oscilloscopes. Higher oscilloscope measurement precision provides better ability to assess corner cases and design margins, perform root cause analysis, and create the best possible solution for any discovered design issue.



	HDO4000A	HDO6000A	HDO8000A	HDO9000
HD Technology	HD4096 12 bits	HD4096 12 bits	HD4096 12 bits	HD1024 10 bits
Bandwidth	200 MHz - 1 GHz	350 MHz - 1 GHz	350 MHz - 1 GHz	1 GHz - 4 GHz
Input Channels	4	4	8	4
Sample Rate	10 GS/s	10 GS/s	10 GS/s	40 GS/s
Standard Toolbox	Basic	Advanced	Advanced	Advanced
Serial Data Tools	TD	TDME	TDME	TDME, SDAII, QPHY
User Experience	MAUI with OneTouch	MAUI with OneTouch	MAUI with OneTouch	MAUI with OneTouch



HD1024 technology provides 10 bits of vertical resolution with 4 GHz bandwidth. As with all members of Teledyne LeCroy's HDO family, the HDO9000 utilizes an exceptionally low-noise system architecture that delivers

outstanding effective number of bits (ENOB). Dynamic ADC Configuration permits the ADC to be set to 8, 9, or 10 bits. Optimized filtering provides additional resolution beyond 10 bits (extending up to 13.8 bits).



DEBUG IN HIGH DEFINITION

The Only 8 Channel,
12 Bit, 1 GHz Oscilloscope

HDO8000A

Lowest Noise and
Unbelievably Powerful

HD4096
High Definition
Technology

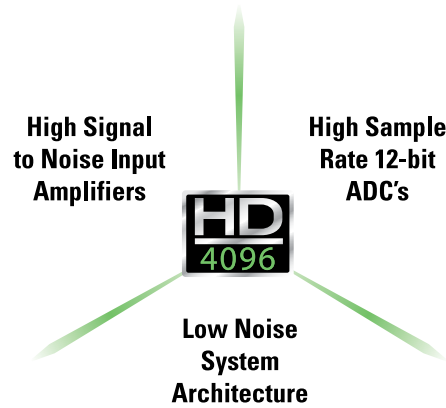

HD4096 technology enables 12 bits of vertical resolution with 1 GHz bandwidth

- Clean, Crisp Waveforms
- More Signal Details
- Unmatched Measurement Precision



**Deep
Toolbox**

**OBSESSED
WITH TOOLS**

HDO8000A has the greatest breadth and depth of tools, ensuring quick resolution of the most complicated debug tasks.

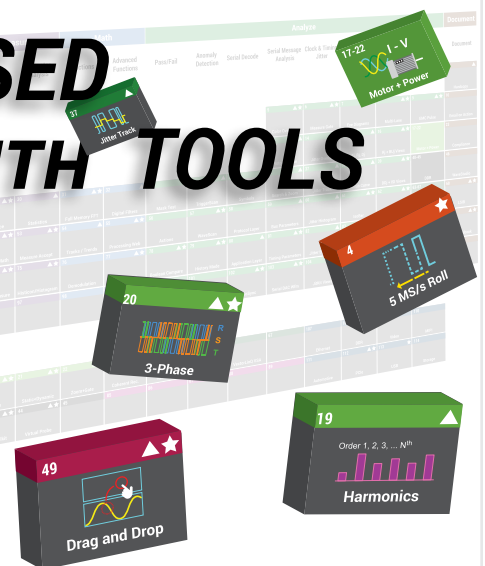

The HDO8000A with **HD4096 Technology** provides **exceptional signal fidelity** with 12-bit resolution and a **superior oscilloscope experience** to deliver **faster time to insight**.

- 1 HD4096 Technology
- 2 Superior User Experience
- 3 Powerful, Deep Toolbox
- 4 Exceptional Serial Data Tools



**Faster
Time to
Insight**

Insight alone is not enough.

Markets and **technologies** change too rapidly.

The **timing** of **critical design decisions** is significant.

Faster Time to Insight is what matters.



MAUI® – SUPERIOR USER EXPERIENCE



MAUI – Most Advanced User Interface was developed to put all the power and capabilities of the modern oscilloscope right at your fingertips. Designed for touch; all important oscilloscope controls are accessed through the intuitive touch screen. Built for simplicity; time saving shortcuts and intuitive dialogs simplify setup. Made to solve; a deep set of debug and analysis tools helps identify problems and find solutions quickly.

Designed for Touch

MAUI is designed for touch. Operate the oscilloscope just like a phone or tablet with the most unique touch screen features on any oscilloscope. All important controls are always one touch away. Touch the waveform to position or zoom in for more details using intuitive actions.

Built for Simplicity

MAUI is built for simplicity. Basic waveform viewing and measurement tools as well as advanced math and analysis capabilities are seamlessly integrated in a single user interface. Time saving shortcuts and intuitive dialogs simplify setup and shorten debug time.

Made to Solve

MAUI is made to solve. A deep set of integrated debug and analysis tools help identify problems and find solutions quickly. Unsurpassed integration provides critical flexibility when debugging. Solve problems fast with powerful analysis tools.

MAUI with OneTouch

MAUI with OneTouch introduces a new paradigm for oscilloscope user experience. Dramatically reduce setup time with revolutionary drag and drop actions to copy and setup channels, math functions, and measurement parameters without lifting a finger. Use common gestures like drag, drop, and flick to instinctively interact with the oscilloscope. Quickly enable a new channel, math or measurement using the “Add New” button and simply turn off any trace or parameter with a flick of the finger. These OneTouch innovations provide unsurpassed efficiency in oscilloscope operation.

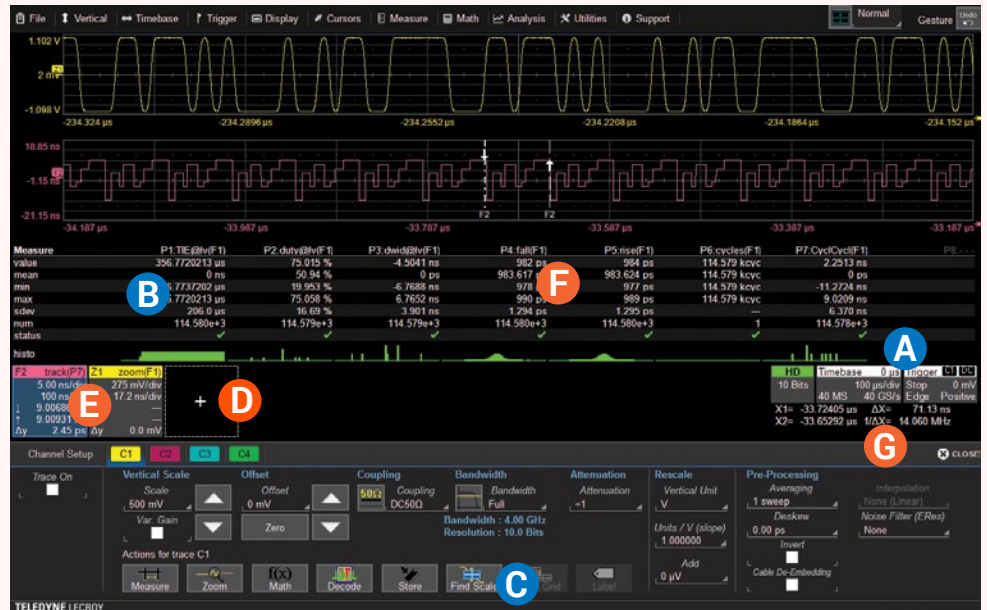

- A** Channel, timebase, and trigger descriptors provide easy access to controls without navigating menus.
- B** Configure parameters by touching measurement results.
- C** Shortcuts to commonly used functions are displayed at the bottom of the channel, math and memory menus.
- D** Use the “Add New” button for one-touch trace creation.
- E** Drag to change source, copy setup, turn on new trace, or move waveform location.
- F** Drag to copy measurement parameters to streamline setup process.
- G** Drag to quickly position cursors on a trace.

POWERFUL, DEEP TOOLBOX

Capture		View			Measure	Math		Analyze								Document																					
Triggering	Acquire	Display Grids	Display Views	Zooming	Parameters	Parameter Analysis	Functions	Advanced Functions	Pass/Fail	Anomaly Detection	Serial Decode	Serial Message Analysis	Clock & Timing Jitter	Serial Data Jitter	Serial Data Analysis	Application Packages	Document																				
1	Exclusion	3	Measurement	4	5 MS/s Roll	11	Multi-, Cascade	12	Sequence Mode	<div style="border: 1px solid black; padding: 5px;"> <p>Element Key:</p> <ul style="list-style-type: none"> ▲ Invented by LeCroy ★ Unique to LeCroy </div>								2	Hardcopy																		
24	Analog+Digital	25	80ch	26	4 to 80 Channels	27	Multi-Grid	28	Segment	29	Multi-Zoom	30	All Instance	31	Statistics	32	Full Memory FFT	33	Digital Filters	34	Mask Test	35	TriggerScan	36	K28.5	37	Symbol	38	Search & Zoom	39	Jitter Track	40-45	Bathub Curve	46	DDR Analysis	47	WaveStudio
47	Serial Data	48	High Definition Technology	49	Drag and Drop	50	Waveform Histogram	51	Vertical Zoom	52	Parameter Math	53	Parameter Acceptance	54	Tracks / Trends	55	Processing Web	56	Actions	57	WaveScan	58	Protocol Layer	59	Bus Parameters	60	Jitter Histogram	61	IsoBER	62	Pj Spectral Views	63-67	Optical	68	LSB		
69	100 GHz / DBI	70	Q-Scope	71	3D Persistence	72	Auto-Scroll	73	Custom Measure	74	Histogram/Histogram	75	Demodulation	76	Custom Math	77	Boolean Compare	78	History Mode	79	Application Layer	80	RPM=1368	81	Timing Parameters	82	Jitter Spectrum	83	Jitter Simulation	84	Noise Analysis	85-89	LabNotebook	90	Automation		
91	Device Loss	92	Control Loop	93	Harmonics	94	3-Phase	95	Static+Dynamic	96	Zoom+Gate	97	Coherent Receiver	98	OpticalLinQ	99	PAM-4 Analysis	100	VectorLinQ VSA	101	Ethernet	102	DDR	103	Video	104	mipi	105	Automotive	106	PCI EXPRESS	107	USB	108	Storage		

Our Heritage

Teledyne LeCroy's 50+ year heritage has its origins in the high-speed collection of data in the field of high-energy physics, and the processing of long records to extract meaningful insight. We didn't invent the oscilloscope, but we did invent the digital oscilloscope, which can take full advantage of advanced digital signal processing and waveshape analysis tools to provide unparalleled insight.

Our Obsession

Our developers are true to our heritage – they are more obsessed with making better and smarter tools than anybody else. Our tools and operating philosophy are standardized across much of our product line for a consistent user experience. Our mission is to help you use these tools to understand problems, including the ones you don't even know you have. Our deep toolbox inspires insight; and your moment of insight is our reward.

Our Invitation

Our Periodic Table of Oscilloscope Tools provides a framework to understand the toolsets that Teledyne LeCroy has created and deployed in our oscilloscopes. Visit our interactive website to learn more about what we offer and how we can help you develop and debug more efficiently.

teledynelecroy.com/tools

HD4096 TECHNOLOGY – 16X CLOSER TO PERFECT

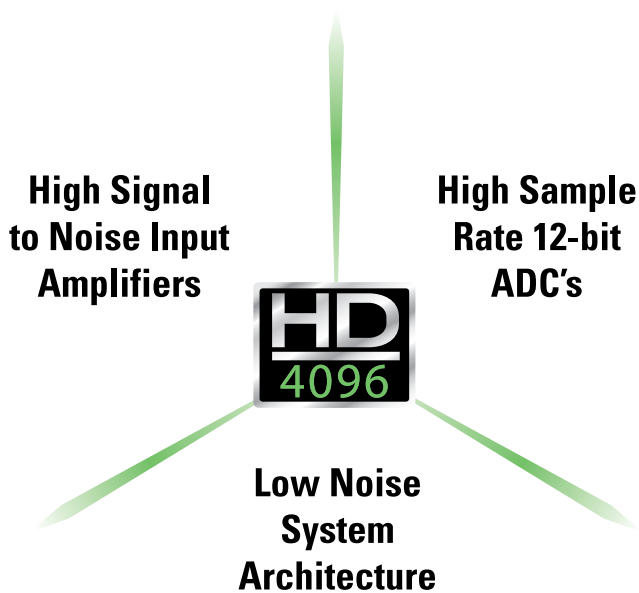

Teledyne LeCroy HDO high definition oscilloscopes use unique HD4096 technology to provide superior and uncompromised measurement performance:

- 12-bit ADCs with high sample rates
- High signal-to-noise amplifiers (55 dB)
- Low noise system architecture (to 1 GHz)

Oscilloscopes with HD4096 technology have higher resolution than conventional 8-bit oscilloscopes (4096 vs. 256 vertical levels) and low noise for uncompromised measurement performance. The 12-bit ADCs support capture of fast signals and oscilloscope bandwidth ratings up to 1 GHz, and Enhanced Sample Rate to 10 GS/s ensures the highest measurement accuracy and precision. The high performance input amplifiers deliver pristine signal fidelity with a 55 dB signal-to-noise ratio. The low-noise system architecture provides an ideal signal path to ensure that signal details are delivered accurately to the oscilloscope display – 16x closer to perfect.

16x Closer to Perfect

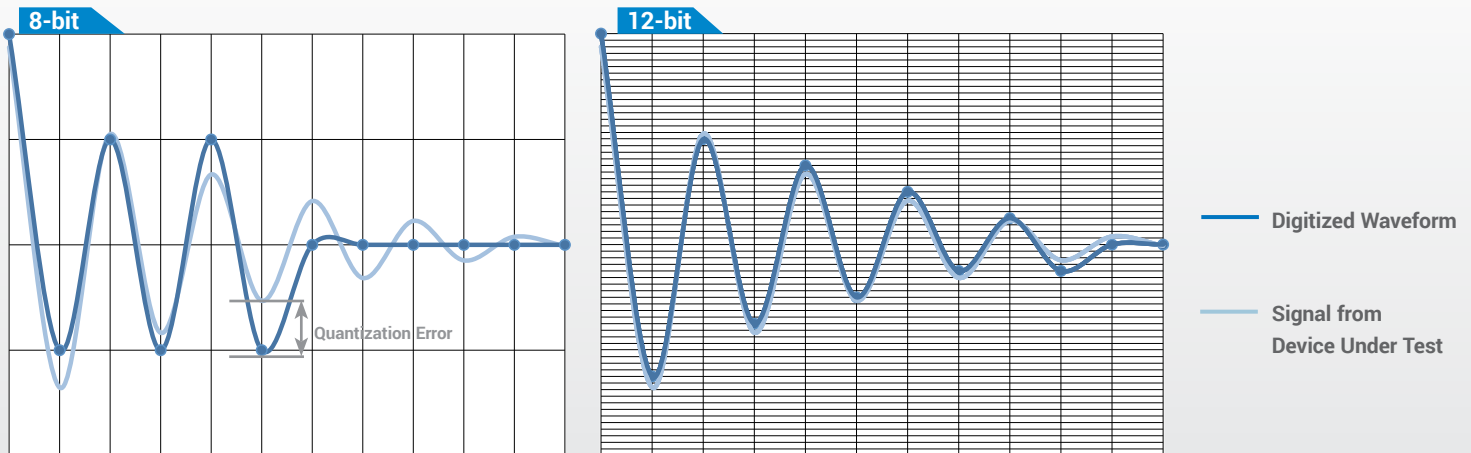

16x More Resolution

HD4096 technology provides 12-bits of vertical resolution with 16x more resolution compared to conventional 8-bit oscilloscopes. The 4096 discrete vertical levels reduce the quantization error compared to 256 vertical levels. This improves the accuracy and precision of the signal capture and increases measurement confidence.

EXPERIENCE THE DIFFERENCE



Experience HD4096 accuracy, detail, and precision and never use an 8-bit oscilloscope again. Whether the application is general-purpose design and debug, high-precision analog, power electronics, automotive electronics, mechatronics, or other specialized applications, the HD4096 technology provides unsurpassed confidence and measurement capabilities.

Clean, Crisp Waveforms

When compared to waveforms acquired and displayed using conventional 8-bit oscilloscopes, waveforms captured with HD4096 12-bit technology are dramatically crisper and cleaner, and are displayed more accurately. Once you see a waveform acquired with HD4096 technology, you will not want to go back to using a conventional 8-bit oscilloscope.

More Signal Details

16x more resolution provides more signal detail. This is especially helpful for wide dynamic range signals in which a full-scale signal must be acquired while at the same time very small amplitude signal details must be analyzed. 12-bit acquisitions combined with the oscilloscope's vertical and horizontal zoom can be used to obtain unparalleled insight to system behaviors and problems.

Unmatched Measurement Precision

HD4096 technology delivers measurement precision several times better than conventional 8-bit oscilloscopes. Higher oscilloscope measurement precision provides better ability to assess corner cases and design margins, perform root cause analysis, and create the best possible solution for any discovered design issue.

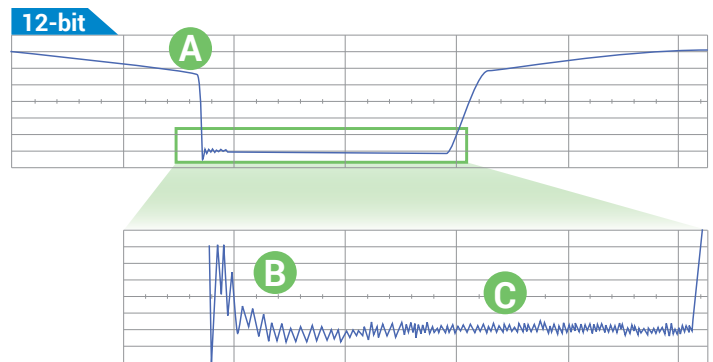
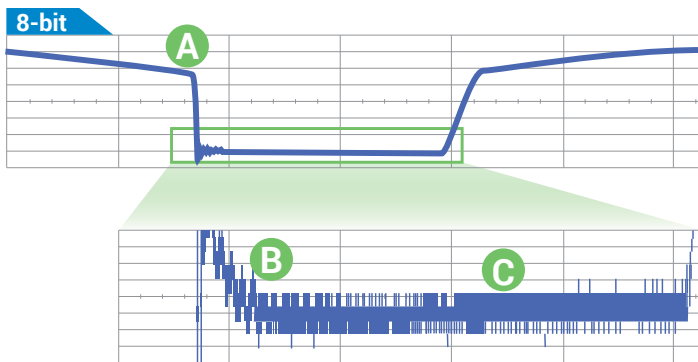

- A Clean, Crisp Waveforms** | Thin traces show the actual waveform with minimal noise interference
- B More Signal Details** | Waveform details lost on an 8-bit oscilloscope can now be clearly seen
- C Unmatched Measurement Precision** | Measurements are more precise and not affected by quantization noise

HDO8000A AT A GLANCE

More channels, more resolution, more bandwidth and more memory than any other mid-range oscilloscope. Ideal for debugging and troubleshooting power electronics, digital power management, automotive electronics, mechatronic, military/avionic, or any embedded systems with high resolution sensor signals. Comprehensive digital logic (MSO), serial data trigger, decode, measure/graph, and eye diagram toolsets, and the widest variety of probes and application packages complete the solution.

Key Features

8 analog channels

12-bit ADC resolution, up to
15-bit with enhanced resolution

350 MHz, 500 MHz and
1 GHz bandwidths

Long Memory – up to 250 Mpts/Ch

16 Digital Channel MSO option

Serial Data Toolsets

- Trigger
- Decode
- Measure/Graph
- Eye Diagram

Q-Scape™ Multi-tab display
architecture

12.1" WXGA multi-touch screen display
with Ultra HD (UHD) 3840 x 2160 pixel
extended-desktop mode

Wide probe selection for power
electronics, embedded electronics,
and mechatronics applications

Advanced analysis and reporting
toolsets

Advanced Triggering supplemented
with TriggerScan and
Measurement Trigger



High-power and/or Three-Phase Power Conversion

Monitor voltages, currents and gate-drives from multiple phases/ legs simultaneously with other DC, control, sensor, and serial data signals. Standard toolsets, software application packages, and the best performing HV probes support full characterization of all aspects of the AC input, inverter subsection, pulse-width modulated outputs, controls and loads.

Automotive Electronics

Automotive electronic control units (ECUs) are tested to stringent standards – more channels provides more insight faster. 12-bits and 250 Mpts provides the amplitude and time resolution needed for better and more intuitive cause-effect analog signal analysis. Deep digital logic capture and extensive serial data toolsets provides an all-in-one characterization tool for the complex, dynamic behavior of the vehicle ECUs.



Digital Power Management, Power Integrity, Power Sequencing

8 channels with 12-bit accuracy and precision and 1 GHz of bandwidth is perfect for transient rail response, rail voltage power integrity, crosstalk and harmonics evaluation, and rail startup/sequencing testing. Specialized probes, analysis software, and serial decoders make fast work of complex embedded system power management and integrity validation.

Deeply Embedded and Mechatronic Systems

Today's consumer appliances and industrial systems combine complex embedded controls, power electronics, and sensors to achieve the highest efficiency and provide important control and other benefits. Time-to-market, cost and quality pressures place exceptional demands on new product test, debug and troubleshooting. 8 channels and 12-bits provides more insight faster.

- 1 8 analog input channels
- 2 12.1" Widescreen (16 x 9) WXGA color multi-touch screen display – Ultra HD (UHD) (3840 x 2160) extended-desktop display.
- 3 Q-Scape multi-tab display architecture – 4x the display area
- 4 Intel® Core™ i7-4790S Quad (core) 4.0 GHz per-core CPU with up to 32 GB of RAM
- 5 ProBus probe interface supports every Teledyne LeCroy probe possible
- 6 Supports eight simultaneous current probes
- 7 Mixed Signal Capability - integrated 16 channel digital logic
- 8 MAUI user interface with OneTouch
- 9 "Push" Knob shortcuts to common actions
- 10 Waveform Control Knobs for channel, zoom, math and memory traces
- 11 Built-in stylus for touch screen
- 12 Dedicated buttons to quickly access popular debug and documentation tools and Q-Scape displays
- 13 Powerful deep toolbox
- 14 Local language user interface front panel overlay

The HDO8000A High Definition Oscilloscopes offer powerful mixed signal solutions that combine high definition analog channels with the flexibility of digital inputs. The HDO8000A MSO options provide an integrated 16 digital channels and a 1.25 GS/s sampling rate to create an all-in-one debug machine.

Integrated 16-Channel Mixed Signal Capability

With embedded systems growing more complex, powerful mixed signal debug capabilities are an essential part of modern oscilloscopes. The 16 integrated digital channels and set of tools designed to view, measure and analyze analog and digital signals enable fast debugging of mixed signal designs.

Advanced Digital Debug Tools

Using the powerful parallel pattern search capability of WaveScan, patterns across many digital lines can be isolated and analyzed. Identified patterns are presented in a table with timestamp information and enables quick searching for each pattern occurrence.

Use a variety of the many timing parameters to measure and analyze the characteristics of digital busses. Powerful tools like tracks, trends, statistics and histicons provide additional insight and help find anomalies.

Quickly see the state of all the digital lines at the same time using convenient activity indicators.

Simulate complete digital designs using logic gate emulation. When used with the web editor, many logic gates can be combined together in one math function to simulate complex logic designs. Choose from AND, OR, NAND, NOR, XOR, NOT and D Flip Flop gates.

Extensive Triggering

Flexible analog and digital cross-pattern triggering across all 20 channels provides the ability to quickly identify and isolate problems in an embedded system. Event triggering can be configured to arm on an analog signal and trigger on a digital pattern.





WaveScan Advanced Search

WaveScan provides powerful isolation capabilities that hardware triggers can't provide. WaveScan allows searching analog, digital or parallel bus signal in a single acquisition using more than 20 different criteria. Or, set up a scan condition and scan for an event over hours or even days. Digital logic patterns can be scanned using the parallel pattern search. Found events can be shown in a table, overlaid in a ScanOverlay for quick visual comparison, or displayed as a ScanHistogram to show the statistical distribution of the events.



Advanced Math and Measure

"All instance" measurements ensure thousands of measurements in a single acquisition. Histograms and Histicons graphically display statistical distributions of up to 2 billion measurement values. Tracks show variation of measurement values over time. Trends provide chart recorder-like views of measurements over many hours or days. More standard measurements and math functions are included than in any other oscilloscope – unleash your potential.

History Mode Waveform Playback

Scroll back in time using History Mode to view previous waveforms and isolate anomalies. Use cursors and measurement parameters to quickly find the source of problems. History mode is always available with a single button press, no need to enable this mode and never miss a waveform. Or use Sequence acquisition mode to capture many fast pulses in quick succession or separated by long periods of time.

Go Back in Time to Identify the Source of a Problem

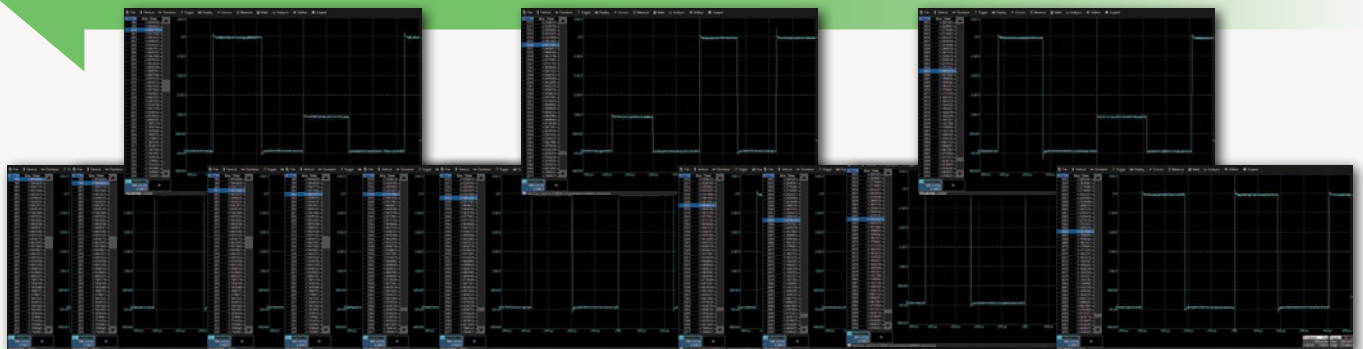

STANDARD TOOLS FOR ADVANCED ANALYSIS

Key Features

Spectrum analyzer style controls for the oscilloscope

Dual Spectrum Capability

Select from six vertical scales (in dB, V, or A)

Automatic frequency peak identification

Display up to 20 markers, with interactive table readout of frequencies and levels

Easily make measurements with reference and delta markers

Automatically identify and mark fundamental frequency and harmonics

Spectrogram shows how spectra changes over time in 2D or 3D views



Use two independent input settings and frequency ranges for advanced spectrum analysis.

Simplify Analysis of FFT Power Spectrum

Get faster and better insight to the frequency content of any signal with use of the Spectrum Analyzer mode on the HDO8000A. This mode provides a spectrum analyzer style user interface with controls for start/stop frequency or center frequency and span. The resolution bandwidth is automatically set for best analysis or can be manually selected. Peak search automatically labels spectral components and presents frequency and level in an interactive table. Utilize up to 20 markers to automatically identify harmonics and quickly analyze frequency content by making measurements between reference and delta markers. Spectrograms display a 2D or 3D history of the frequency content to provided insight into how the spectrum changes over time.

Q-Scope Multi-Tab Display Architecture

Q-Scope tabbed displays maximize the display area and provide faster insight. Acquired or calculated waveforms can be located on any of four different "tabbed" oscilloscope grid displays, with individually selectable grid styles available for each tab. Q-Scope is ideal for complex analysis with many analog and digital acquired and calculated waveforms.

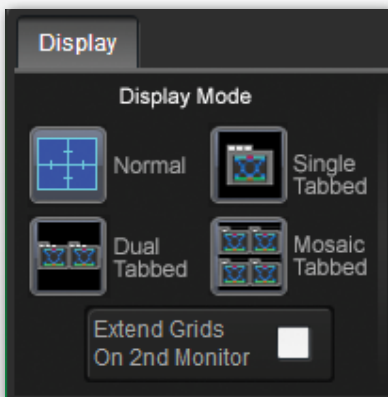

EXCEPTIONAL SERIAL DATA TOOLS

The HDO8000A features the widest range and most complete serial data debug toolsets.

- Triggering
- Decoding
- Measurement and Graphing
- Eye Diagram and Physical Layer Analysis

Solutions address the following markets and applications:

- Embedded Computing
- Automotive
- Industrial
- Military and Avionics
- Peripherals
- Handset/Mobile/Cellular
- Serial Digital Audio

T D

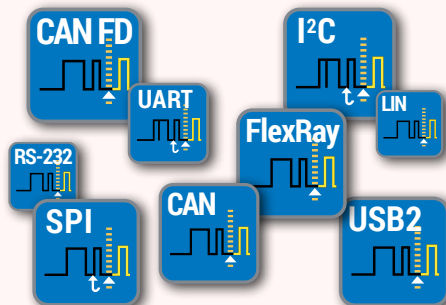

Trigger

Powerful, flexible triggers designed by people who know the standards, with the unique capabilities you want to isolate unusual events. Conditional data triggering permits maximum flexibility and highly adaptable error frame triggering is available to isolate error conditions. Efficiently acquire bursted data using Sequence Mode to maximize the oscilloscope's memory usage. Sequence Mode enables the oscilloscope to ignore idle time and acquire only data of interest.

Decode

Decoded protocol information is color-coded to specific portions of the serial data waveform and transparently overlaid for an intuitive, easy-to-understand visual record. All decoded protocols are displayed in a single time-interleaved table. Touch a row in the interactive table to quickly zoom to a packet of interest and select a column header to create filter criteria, as is commonly done in spreadsheets. Easily search through long records for specific protocol events using the built-in search feature.

MME

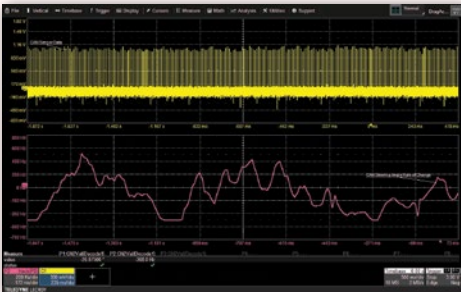

Measure/Graph

Quickly validate cause and effect with automated timing measurements to or from an analog signal or another serial message. Make multiple measurements in a single long acquisition to quickly acquire statistics during corner-case testing. Serial (digital) data can be extracted to an analog value and graphed to monitor system performance over time, as if it was probed directly. Complete validation faster and gain better insight.

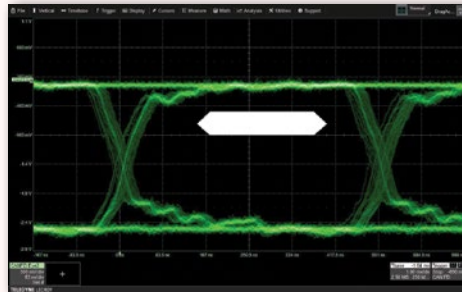

Eye Diagram

Rapidly display an eye diagram of your packetized low-speed serial data signal without additional setup time. Use eye parameters to quantify system performance and apply a standard or custom mask to identify anomalies. Mask failures can be indicated and can force the scope into Stop mode.

HDO8000A Serial Data Protocol Support

	Trigger	Decode	Measure/Graph	Eye Diagram
Embedded Computing	I ² C	•	•	•
	SPI	•	•	•
	UART-RS232	•	•	•
	USB2-HSIC		•	
Automotive + Industrial	CAN	•	•	•
	CAN FD	•	•	•
	FlexRay	•	•	•
	LIN	•	•	•
	SENT		•	
Avionics	ARINC429		•	•
	MIL-STD-1553	•	•	•
	SPACEWIRE		•	
Computing + Peripherals	Ethernet (10/100Base-T)		•	
	MDIO		•	
	USB 1.1/2.0	•	•	•
	8b/10b	•	•	•
	D-PHY/CSI-2/DSI		•	•
MIPI	DigRF3G		•	•
	DigRFv4		•	•
	SPMI		•	
Other	Audio (I ² S, LJ, RJ, TDM)	•	•	•
	Manchester		•	
	NRZ	•	•	•



Key Features

Automated measurement zone identification with color-coded overlays

Control loop and time domain response analysis

Line power and harmonics tests to IEC 61000-3-2

Total harmonic distortion table shows frequency contribution

B-H Curve shows magnetic device saturation

Device and Power Supply Measurements Option (HD08K-PWR)

Quickly measure and analyze the operating characteristics of power conversion devices and single-phase circuits with the PWR Power Analysis option. Switching/conduction device measurements, control loop modulation analysis, and line power harmonic testing are all provided. Areas of turn-on, turn-off, and conduction loss are all identified with color-coded waveform overlays. Use with long memory to understand dynamic performance of devices and control loops.

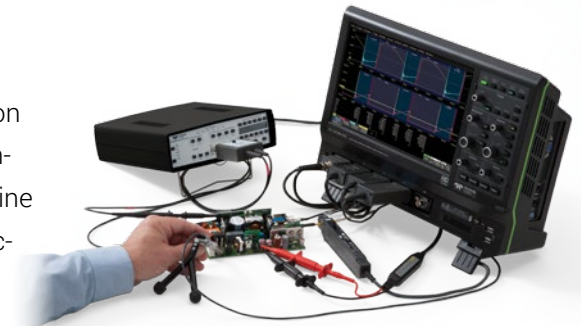

Key Features

Oscilloscope and Power Analyzer in one instrument

Dynamic Power Analysis during long captures

Zoom+Gate mode

Comprehensive speed and torque interface

Harmonic Analysis option (MDA800-HARMONICS)

Three-Phase Electrical and Mechanical Power Analysis (MDA Models)

Motor Drive Analyzers (MDA Models) provide complete static and dynamic three-phase electrical and mechanical power analysis with results in a convenient Numerics table. Motor speed, position, and torque sensor interface support is the most comprehensive available. Long memory, per-cycle "synthesized" Waveforms and Zoom+Gate mode provide powerful dynamic drive and motor analysis.



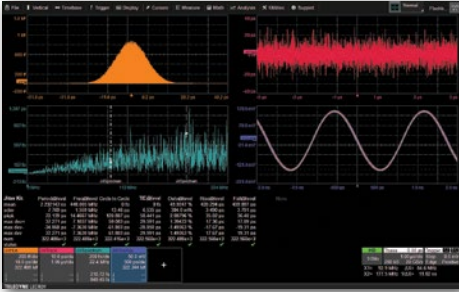

Jitter and Timing Analysis Option (HDO8K-JITKIT)

JITKIT makes it simple and easy to understand the basic system jitter performance of clock signals and clock-data activities. It quickly provides four views of jitter (JitTrack, JitOverlay, JitHistogram and JitSpectrum) and time-correlation to causal or other events shown in acquired channels or math traces. A convenient table provides direct readout of jitter values (any eight of more than 25 provided jitter measurements).

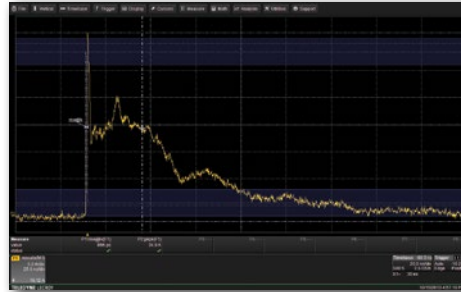

EMC Pulse Parameter Analysis Option (HDO8K-EMC)

The EMC software package provides customizable parameters to measure rise time, fall time, or width characteristics according to specific EMC/ESD standards for ESD, EFT, Surge, or Transient pulses, of Voltage Dips and Interrupts. Level selections can be made to ignore undershoot, overshoot, or tail perturbations, making it easy to capture and verify repetitive pulse sequences without the need to use time-consuming cursors.



Digital Power Management and Power Integrity Analysis Option (HDO8K-DIG-PWR-MGMT)

The DIG-PWR-MGMT package translates complicated multi-phase PMIC, VRM, POL, LDO and other DC rail behaviors into per-cycle measurements and Waveforms to provide complete and fast understanding of power rail behaviors, such as ripple, ringing, droop, noise, settling time, etc. Ideally used with the RP4030 Active Voltage/Power Rail Probe..



Digital Filter Software Option (HDO8K-DFP2)

DFP2 lets you implement Finite Impulse Response (FIR) or Infinite Impulse Response (IIR) filters to eliminate undesired spectral components, such as noise, and enhances your ability to examine important signal components. You can choose from a standard set of FIR or IIR filters or you can also design your own custom filters. Create and apply a variety of FIR and IIR digital filters to your capture waveforms or processed traces.

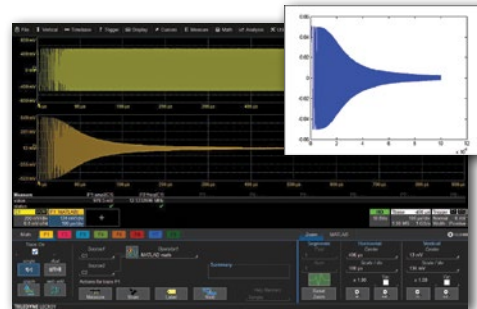

XDEV Advanced Customization Option (HDO8K-XDEV)

With the XDEV option, third party programs can be completely integrated into the oscilloscope's processing stream. Create customized math functions and parameters using C/C++, MATLAB®, Excel, JScript or Visual Basic without ever leaving the oscilloscope application - and view the results directly on the oscilloscope, in real-time.

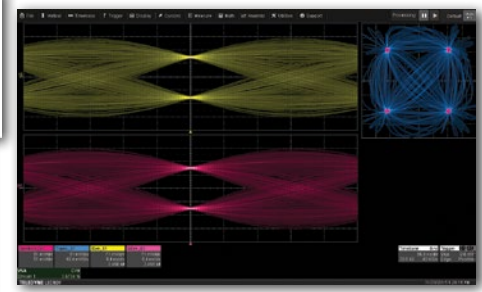

VectorLinQ VSA Option (HDO8K-VECTORLINQ)

The VectorLinQ Vector Signal Analysis (VSA) option provides an extensive toolset for demodulation and analysis of RF and IQ modulated signals. These tools provide deep insight into advanced signal types with maximum measurement flexibility and sophisticated signal visualization. The intuitive user interface is easy to set up and allows for user customization to meet the needs of even the most complex signals.

Teledyne LeCroy offers an extensive range of probes to meet virtually every probing need.

ZS Series High Impedance

Active Probes

ZS1000, ZS1000-QUADPAK
ZS1500, ZS1500-QUADPAK



High input impedance (1 MΩ), low 0.9 pF input capacitance and an extensive set of probe tips and ground accessories make these low-cost single-ended probes ideal for a wide range of applications. The ZS Series is available up to 4 GHz bandwidth.

Differential Probes

(200 MHz – 1.5 GHz)

ZD1500, ZD1000,
ZD500, ZD200
AP033



High bandwidth, excellent common-mode rejection ratio (CMRR) and low noise make these active differential probes ideal for applications such as automotive electronics and data communications. AP033 provides 10x gain for high-sensitivity measurement of series/shunt resistor voltages.

Active Voltage/Power

Rail Probe

RP4030



Specifically designed to probe a low impedance power/voltage rail. The RP4030 has 30V built-in offset adjust, low attenuation (noise), and high DC input impedance with 4 GHz of bandwidth and a wide assortment of tips and leads, including solder-in and U.FL receptacle connections.

High Voltage

Fiber Optically-isolated Probe

HVFO103



The HVFO103 is a compact, simple, affordable probe for measurement of small signals (gate-drives, sensors, etc.) floating on an HV bus in power electronics designs, or for EMC, EFT, ESD, and RF immunity testing sensor monitoring. Suitable for up to 35kV common-mode. 140 dB CMRR.

HVD Series High Voltage

Differential Probes

HVD3102, HVD3106 (1 kV)
HVD3206 (2 kV)
HVD3605 (6 kV)



Available with 1, 2 or 6kV common-mode ratings. Excellent CMRR (65 dB @ 1 MHz) at high frequencies is combined with low inherent noise, wide differential voltage range, high offset voltage capabilities, and 1% gain accuracy. The ideal probe for power conversion system test.

High Voltage

Passive Probes

HVP120,
PPE4KV, PPE5KV, PPE6KV



The HVP and PPE Series includes four fixed-attenuation probes covering a range from 1 kV to 6 kV. These probes are ideal for lightning/surge or EFT testing, or for probing in-circuit beyond the range of a LV-rate passive probe.

Differential Amplifier

DA1855A
DXC100A, DXC200
DXC-5100, DA101



The DA1855A is a stand-alone high performance 100 MHz differential amplifier with 100 dB CMRR and HV common-mode when combined with a suitable probe pair (sold separately). It is ideal for semiconductor device conduction/switching loss or high sensitivity voltage measurements.

Current Probes

CP030, CP030-3M, CP030A
CP031, CP031A
CP150, CP150-6M
CP500, DCS015



Available in bandwidths up to 100 MHz with peak currents of 700 A and sensitivities to 1 mA/div. Extra-long cables (3 or 6 meters) available on some models. Ideal for component or power conversion system input/output measurements. DCS015 deskew calibration source also available.

Probe and Current Sensor

Adapters

TPA10, TPA10-QUADPAK
CA10, CA10-QUADPAK



TPA10 adapts supported Tektronix TekProbe-compatible probes to Teledyne LeCroy ProBus interface. CA10 is a programmable adapter for third-party current sensors that have voltage or current outputs proportional to measured current. QUADPAKS of four pieces each are available.

SPECIFICATIONS



	HDO8038A	HDO8058A	HDO8108A
Vertical - Analog Channels			
Bandwidth @ 50 Ω (-3 dB)	350 MHz	500 MHz	1 GHz
Rise Time (10–90%, 50 Ω)	1 ns	700 ps	450 ps
Input Channels	8		
Vertical Resolution	12-bits; up to 15-bits with enhanced resolution (ERES)		
Effective Number of Bits (ENOB)	8.7 bits	8.6 bits	8.4 bits
Vertical Noise Floor			
1 mV/div	85 uVrms	100 uVrms	145 uVrms
2 mV/div	85 uVrms	100 uVrms	145 uVrms
5 mV/div	90 uVrms	105 uVrms	150 uVrms
10 mV/div	95 uVrms	110 uVrms	155 uVrms
20 mV/div	110 uVrms	130 uVrms	185 uVrms
50 mV/div	210 uVrms	265 uVrms	275 uVrms
100 mV/div	360 uVrms	450 uVrms	500 uVrms
200 mV/div	1.10 mVrms	1.25 mVrms	1.75 mVrms
500 mV/div	2.10 mVrms	2.60 mVrms	2.75 mVrms
1 V/div	3.70 mVrms	4.50 mVrms	4.90 mVrms
Sensitivity	50 Ω: 1 mV/div–1 V/div, fully variable 1 MΩ: 1 mV/div–10 V/div, fully variable		
DC Vertical Gain Accuracy (Gain Component of DC Accuracy)	±(0.5%) F.S, offset at 0 V		
Channel-Channel Isolation	DC-200 MHz: 60 dB (>1000:1), 200 MHz up to rated BW: 50 dB (>300:1), (For any two input channels, same v/div settings, typical)	DC-200 MHz: 60 dB (>1000:1), 200 MHz up to rated BW: 50 dB (>300:1), (For any two input channels, same v/div settings, typical)	DC-200 MHz: 60 dB (>1000:1), 200-500 MHz: 50 dB (>300:1), 500 MHz up to rated bandwidth: 40 dB (>100:1) (For any two input channels, same v/div settings, typical)
Offset Range	50 Ω: 1 mV - 4.95 mV: ±1.6 V, 5 mV - 9.9 mV: ±4 V, 10 mV - 19.8 mV: ±8 V, 20 mV - 1 V: ±10 V 1 MΩ: 1 mV - 4.95 mV: ±1.6 V, 5 mV - 9.9 mV: ±4 V, 10 mV - 19.8 mV: ±8 V, 20 mV - 100 mV: ±16 V, 102 mV - 198 mV: ±80V, 200 mV - 1 V: ±160 V, 1.02 V -10 V: ±400 V		
DC Vertical Offset Accuracy	±(1.0% of offset setting + 0.5%FS + 0.02% of max offset + 1mV)		
Maximum Input Voltage	50 Ω: 5 Vrms, 1 MΩ: 400 V max (DC + Peak AC ≤ 10 KHz)		
Input Coupling	50 Ω: DC, GND; 1 MΩ: AC, DC, GND;		
Input Impedance	50 Ω ± 2.0%; 1 MΩ ± 2.0% 16 pF,		
Bandwidth Limiters	20 MHz, 200 MHz		
Horizontal - Analog Channels			
Acquisition Modes	Real-time, Roll, Random Interleaved Sampling (RIS), Sequence		
Time/Division Range	20 ps/div - 5 ks/div with standard memory (up to 10 ks/div with -L memory, 25 ks/div with -XL memory); RIS available at ≤ 10 ns/div; Roll Mode available at ≥ 100 ms/div and ≤ 5 MS/s		
Clock Accuracy	±2.5 ppm + 1.0ppm/year from calibration		
Sample Clock Jitter	Up to 10 ms acquired time range: 280 fsrms (internal timebase reference)		
Delta Time Measurement Accuracy	$\sqrt{2} * \sqrt{\left(\frac{\text{Noise}}{\text{SlewRate}}\right)^2 + (\text{Sample Clock Jitter})^2 \text{ (RMS)} + (\text{clock accuracy} * \text{reading}) \text{ (seconds)}}$		
Jitter Measurement Floor	$\sqrt{\left(\frac{\text{Noise}}{\text{SlewRate}}\right)^2 + (\text{Sample Clock Jitter})^2 \text{ (RMS, seconds, TIE)}}$		
Jitter Between Channels	Analog Channels: 2 psrms (TIE, typical) Digital Channels: 350 ps (maximum) between any two channels Analog-Digital Channels: <5ns (maximum) between any analog and any digital channel		
Channel-Channel Deskew Range	±9 x time/div. setting, 100 ms max., each channel		
External Timebase Reference (Input)	10 MHz ±25 ppm at 0 to 10 dBm into 50 Ω		
External Timebase Reference (Output)	10 MHz, 2.0 dBm ±1.5 dBm, sinewave synchronized to reference being used (internal or external reference)		
External Clock	DC to 100 MHz; (50 Ω/1 MΩ), EXT BNC input, for acquisition of channels 1-4 (channels 5-8 disabled). Minimum rise time and amplitude requirements apply at low frequencies		

HDO8038A

HDO8058A

HDO8108A

Acquisition - Analog Channels

Sample Rate (Single-shot)	10 GS/s on all 8 Channels with Enhanced Sample Rate
Sample Rate (Repetitive)	125 GS/s, user selectable for repetitive signals (20 ps/div to 10 ns/div)
Memory Length (Number of Segments in Sequence Acquisition Mode)	Standard: 50 Mpts/ch for all channels (30,000 segments) Option - L: 100 Mpts/ch for all channels (60,000 segments) Option -XL: 250 Mpts/ch for all channels (65,000 segments)
Intersegment Time	1 μ S
Averaging	Summed averaging to 1 million sweeps; continuous averaging to 1 million sweeps
Enhanced Resolution (ERES)	From 12.5- to 15-bits vertical resolution
Envelope (Extrema)	Envelope, floor, or roof for up to 1 million sweeps
Interpolation	Linear or Sin x/x (2 pt and 4 pt); 5 or 10 GS/s Enhanced Sample Rate defaults to 2 pt or 4 pt Sin x/x respectively

Vertical, Horizontal, Acquisition - Digital Channels (with HDO8k-MSO option only)

Input Channels	16 Digital Channels
Threshold Groupings	Pod 2: D15 - D8, Pod 1: D7 - D0
Threshold Selections	TTL, ECL, CMOS (2.5 V, 3.3 V, 5 V), PECL, LVDS or User Defined
Maximum Input Voltage	\pm 30V Peak
Threshold Accuracy	\pm (3% of threshold setting + 100mV)
Input Dynamic Range	\pm 20V
Minimum Input Voltage Swing	400mV
Input Impedance (Flying Leads)	100 k Ω 5 pF
Maximum Input Frequency	250 MHz
Sample Rate	1.25 GS/s
Record Length	Standard: 50 MS - 16 Channels Optional -L: 100 MS - 16 Channels Optional -XL: 125 MS - 16 Channels
Minimum Detectable Pulse Width	2 ns
Channel-to-Channel Skew	350 ps
User Defined Threshold Range	\pm 10 V in 20 mV steps
User Defined Hysteresis Range	100 mV to 1.4 V in 100 mV steps

	HDO8038A	HDO8058A	HDO8108A
Triggering System			
Modes	Normal, Auto, Single, and Stop		
Sources	Any input channel, External, Ext/10, or line; slope and level unique to each source (except for line trigger)		
Coupling	DC, AC, HFRej, LFRej		
Pre-trigger Delay	0-100% of memory size (adjustable in 1% increments of 100 ns)		
Post-trigger Delay	0-10,000 Divisions in real time mode, limited at slower time/div settings or in roll mode		
Hold-off	From 2 ns up to 20 s or from 1 to 99,999,999 events		
Trigger and Interpolator Jitter	≤ 4.0 ps rms (typical) <0.1 ps rms (typical, software assisted)	≤ 3.5 ps rms (typical) <0.1 ps rms (typical, software assisted)	≤ 3.5 ps rms (typical) <0.1 ps rms (typical, software assisted)
Internal Trigger Level Range	±4.1 div from center (typical)		
External Trigger Input Range	Ext: ±400 mV, Ext/10: ±4 V		
Maximum Trigger Rate	1,000,000 waveforms/sec (in Sequence Mode, up to 8 channels)		
Trigger Sensitivity with Edge Trigger (Ch 1–8)	0.9 division: 10 MHz 1.0 divisions: 200 MHz 2.0 divisions: 350 MHz	0.9 division: 10 MHz 1.0 divisions: 200 MHz 1.5 divisions: 250 MHz 2.0 divisions: 500 MHz	0.9 division: 10 MHz 1.0 divisions: 200 MHz 1.5 divisions: 500 MHz 2.0 divisions: 1 GHz
Trigger Sensitivity with Edge Trigger (External Input)	0.9 division: 10 MHz 1.0 divisions: 200 MHz 2.0 divisions: 350 MHz	0.9 division: 10 MHz 1.0 divisions: 200 MHz 1.5 divisions: 250 MHz 2.0 divisions: 500 MHz	0.9 division: 10 MHz 1.0 divisions: 200 MHz 1.5 divisions: 500 MHz 2.0 divisions: 1 GHz
Max. Trigger Frequency, Smart Trigger	350 MHz	500 MHz	1 GHz

Trigger Types

Edge	Triggers when signal meets slope (positive, negative, or either) and level condition
Width	Triggers on positive or negative glitches with selectable widths. Minimum width 1.5ns, Maximum width: 20 s
Glitch	Triggers on positive or negative glitches with selectable widths. Minimum width 1.5ns, Maximum width: 20 s
Window	Triggers when signal exits a window defined by adjustable thresholds
Pattern	Logic combination (AND, NAND, OR, NOR) of up to 9 inputs (8 channels and external trigger input). Each source can be high, low, or don't care. The High and Low level can be selected independently. Triggers at start or end of the pattern.
TV-Composite Video	Triggers NTSC or PAL with selectable line and field; HDTV (720p, 1080i, 1080p) with selectable frame rate (50 or 60 Hz) and Line; or CUSTOM with selectable Fields (1–8), Lines (up to 2000), Frame Rates (25, 30, 50, or 60 Hz), Interlacing (1:1, 2:1, 4:1, 8:1), or Synch Pulse Slope (Positive or Negative)
Runt	Trigger on positive or negative runts defined by two voltage limits and two time limits. Select between 1 ns and 20 ns
Slew Rate	Trigger on edge rates. Select limits for dV, dt, and slope. Select edge limits between 1 ns and 20 ns
Interval	Triggers on intervals selectable between 1 ns and 20 s
Dropout	Triggers if signal drops out for longer than selected time between 1 ns and 20 s
Triggers with Exclusion Technology	Glitch, Width, Interval, Runt, Slew Rate - Trigger on intermittent faults by specifying the expected behavior and triggering when that condition is not met
Measurement Trigger	Select from a large number of measurement parameters. Trigger on measurement with qualified limits.
Multi-Stage: Qualified (Timeout or State/Edge Qualified)	Triggers on any input source only if a defined state or edge occurred on another input source. Delay between sources is selectable by time or events. (Note: event B pattern trigger cannot include analog channels).
Multi-Stage: Qualified First	In Sequence acquisition mode, triggers repeatably on event B only if a defined pattern, state, or edge (event A) is satisfied in the first segment of the acquisition. Holdoff between sources is selectable by time or events. (Note: event B pattern trigger cannot include analog channels).
TriggerScan	A Trigger Trainer analyzes the waveforms, identifies normal behavior, and then sets up a large set of rare event smart trigger setups that target abnormal behavior. The trainer 'learns' trigger setups based on slew rates, periods, amplitudes outside of a range and then applies them sequentially.
Low Speed Serial Protocol Trigger (Optional)	I2C, SPI (SPI, SSPI, SIOP), UART-RS232, CAN1.1, CAN2.0, CAN FD, LIN, FlexRay, MIL-STD-1553, AudioBus (I2S, LJ, RJ, TDM), USB1.x/2.0

HDO8038A

HDO8058A

HDO8108A

Measurement Tools

Measurement Functionality	Display up to 12 measurement parameters together with statistics, including mean, minimum, maximum, standard deviation, and total number. Each occurrence of each parameter is measured and added to the statistics table. . Histicons provide a fast, dynamic view of parameters and wave shape characteristics. Parameter Math allows addition, subtraction, multiplication, or division of two different parameters. Parameter gates define the location for measurement on the source waveform. Parameter accept criteria define allowable values based on range setting or waveform state.
Measurement Parameters - Horizontal + Jitter	Cycles (number of), Delay (from trigger, 50%), Δ Delay (50%), Duty Cycle (50%, @level), Edges (number of, @level), Fall Time (90-10, @levels), Frequency (50%, @level), Half Period (@level), Hold Time (@level), N Cycle Jitter (peak-peak), Number of Points, Period (50%, @level), Δ Period (@level), Phase (@level), Rise Time (10-90, @levels), Setup (@levels), Skew (@levels), Slew Rate (@levels), Time Interval Error (@level), Time (@level), Δ Time (@level), Width (50%, @level), Δ Width (@level), X(value)@max, X(value)@min
Measurement Parameters - Vertical	Amplitude, Base, Level@X, Maximum, Mean, Median, Minimum, Peak-to-Peak, RMS, Std. Deviation, Top.
Measurement Parameters - Pulse	Area, Base, Fall Time (90-10, 80-20, @levels), Overshoot (positive, negative), Rise Time (10-90, 80-20, @levels), Top, Width (50%)
Measurement Parameters - Statistical (on Histograms)	Full Width (@ Half Max, @ %), Amplitude, Base, Peak @ Max Population, Maximum, Mean, Median, Minimum, Mode, Range, RMS, Std. Deviation, Top, X(value)@Peak, Peaks (number of), Percentile, Population (@bin, total)

Math Tools

Math Functionality	Display up to 12 math functions traces (F1-F12). The easy-to-use graphical interface simplifies setup of up to two operations on each function trace, and function traces can be chained together to perform math-on-math..
Math Operators - Basic Math	Average (summed), Average (continuous), Difference (-), Envelope, Floor, Invert (negate), Product (x), Ratio (/), Reciprocal, Rescale (with units), Roof, Sum (+).
Math Operators - Digital (included with HDO8k-MSO option)	Digital AND, Digital DFlipFlop, Digital NAND, Digital NOR, Digital NOT, Digital OR, Digital XOR
Math Operators - Filters	Enhanced resolution (to 15 bits vertical), Interpolate (cubic, quadratic, $\sin x/x$), $(\sin X)/x$.
Math Operators - Frequency Analysis	FFT (power spectrum, magnitude, phase, power density, real, imaginary, magnitude squared), up to full record length. Select from Rectangular, VonHann, Hamming, FlatTop and Blackman Harris windows.
Math Operators - Functions	Absolute value, Correlation (two waveforms), Derivative, Deskew (resample), Exp (base e), Exp (base 10), Integral, Invert (negate), Log (base e), Log (base 10), Reciprocal, Rescale (with units), Square, Square root, Zoom (identity).
Math Operators - Other	Segment, Sparse

Measurement and Math Integration

Histograms to display statistical distributions of up to 2 billion measurement parameters. Trend (datalog) of up to 1 million measurement parameters. Track (display parameter vs. time, time-correlated to acquisitions) any parameter. Persistence histogram and persistence trace (mean, range, sigma)

Pass/Fail Testing

Pass/Fail Testing	Display up to 8 pass/fail queries using a Single or Dual Parameter Comparison (compare All values, or Any value $<$, \leq , $=$, $>$, \geq , within limit $\pm\Delta$ value or %) or Mask Test (pre-defined or user-defined mask, waveform All In, All Out, Any In, or Any Out conditions). Combine queries into a boolean expression to Pass or Fail IF "All True", "All False", "Any True", "Any False", or groups or "All" or "Any", with following THEN Save (waveforms), Stop, Alarm, (send) Pulse, Hardcopy (send email, save screen image, save to clipboard, send to printer), or (save) LabNotebook.
-------------------	--

Display System

Display Size	Color 12.1" widescreen flat panel TFT-Active Matrix with high resolution touch screen
Display Resolution	WXGA; 1280 x 800 pixels
Number of Traces	Display a maximum of 40 traces. Simultaneously display channel, zoom, memory, math, and X-Y traces
Grid Styles	Auto, Single, Dual, Triplex, Quad, Octal, Tandem, Triad, Quattro, Twelve, Sixteen, Twenty, X-Y, Single+X-Y, Dual+X-Y, DualX-Y, TripleX-Y, QuattroX-Y, HexX-Y, OctalX-Y, DualX-YSingle, DualX-YDual, HexX-Ydual. Supports Normal Display Mode (1 grid style, selectable) or Q-Scape Display Mode (4 different tabs, each with individually selectable grid styles). Q-Scape tabbed displays may be viewed in Single, Dual, or Mosaic mode..
Waveform Representation	Sample dots joined, or sample dots only

HDO8038A

HDO8058A

HDO8108A

Processor/CPU

Type	Intel® Core™ i7-4790S Quad, 3.2 GHz (4.0 GHz in turbo mode) (or better)
Processor Memory	16 GB standard for standard memory (50 Mpt) with 32 GB optional. 32 GB standard for -L and -XL memory options.
Operating System	Microsoft Windows® 7 Pro 64-Bit Embedded
Oscilloscope Operating Software	Teledyne LeCroy MAUI™ with OneTouch

Connectivity

Ethernet Port	Supports 2 10/100/1000BaseT Ethernet interface (RJ45 ports)
USB Host Ports	Minimum 6 total: 2 front panel USB2.0 and 4 rear-mounted USB3.0 support Windows compatible devices
USB Device Port	1 USBTMC port
GPIO Port (Optional)	Supports IEEE – 488.2 (External)
External Monitor Port	DisplayPort 1.2 compatible to support customer-supplied external monitor. Includes support for extended desktop operation with UHD 3840 x 2160 pixel resolution and split-grid capability on external monitor. Supports touch screen integration of external monitor (Note: external display can not use a Fujitsu touch-screen driver).
Remote Control	Via Windows Automation, or via Teledyne LeCroy Remote Command Set

Probes

Standard Probes	Qty. (4) ±10 Passive Probes
Probing System	ProBus. Automatically detects and supports a variety of compatible probes

Power Requirements

Voltage	100–240 VAC ±10% at 45-66 Hz; 110-120 VAC ±10% at 380-420 Hz; Automatic AC Voltage Selection; Installation Category 300 V CAT II
Power Consumption (Nominal)	400 W / 400 VA
Max Power Consumption	550 W / 550 VA (with all PC peripherals and active probes connected to 8 channels)

Environmental

Temperature	Operating: 5 °C to 40 °C; Non-Operating: -20 °C to 60 °C
Humidity	Operating: 5% to 90% relative humidity (non-condensing) up to +31 °C, Upper limit derates to 50% relative humidity (non-condensing) at +40 °C; Non-Operating: 5% to 95% relative humidity (non-condensing) as tested per MIL-PRF-28800F
Altitude	Operating: 3,048 m (10,000 ft) max at +30 °C; Non-Operating: Up to 12,192 meters (40,000 ft)
Random Vibration	Operating : 0.31 g _{rms} 5 Hz to 500 Hz, 15 minutes in each of three orthogonal axes; Non-Operating: 2.4 g _{rms} 5 Hz to 500 Hz, 15 minutes in each of three orthogonal axes
Functional Shock	30 g _{peak} , half sine, 11 ms pulse, 3 shocks (positive and negative) in each of three orthogonal axes, 18 shocks total

Physical

Dimensions (HWD)	14.8"H x 16.4"W x 11"D (375 mm x 416 mm x 280 mm)
Weight	26.8 lbs (12.2 kg)

Certifications

CE Certification UL and cUL Listing	CE Compliant, UL and cUL listed, confirms to: UL 61010-1 (3rd Edition), UL 61010-2-030 (1st Edition) CAN/CSA C22.2 No.61010-1-12
	CE Compliant, UL and cUL listed, confirms to: UL 61010-1 (3rd Edition), UL 61010-2-030 (1st Edition) CAN/CSA C22.2 No.61010-1-12

Warranty and Service

3-year warranty; calibration recommended annually. Optional service programs include extended warranty, upgrades, and calibration services

Product Description	Product Code
HDO8000A Oscilloscopes	
350 MHz, 8 Ch, 12-bit, 10 GS/s, 50 Mpts/Ch High Definition Oscilloscope with 12.1" WXGA Color Touch-screen Display, Ultra HD (UHD) Extended Desktop	HDO8038A
500 MHz, 8 Ch, 12-bit, 10 GS/s, 50 Mpts/Ch High Definition Oscilloscope with 12.1" WXGA Color Touch-screen Display, Ultra HD (UHD) Extended Desktop	HDO8058A
1 GHz, 8 Ch, 12-bit, 10 GS/s, 50 Mpts/Ch High Definition Oscilloscope with 12.1" WXGA Color Touch-screen Display, Ultra HD (UHD) Extended Desktop	HDO8108A

Mixed Signal Oscilloscope Option	Product Code
HDO8000A Series Model Mixed Signal Option	HDO8k-MSO

Included with Standard HDO8000A Configurations
 ±10 Passive Probe (Qty. 4), Getting Started Guide, Anti-virus Software (Trial Version), Microsoft Windows Embedded Standard 7 P 64-Bit License, Commercial NIST Traceable Calibration with Certificate, Power Cable for the Destination Country, 3-year Warranty

Included with HDO8k-MSO Option
 16 Channel Digital Leadset, Extra Large Gripper Probe Set (Qty. 22), Ground Extenders (Qty. 20), Flexible Ground Leads (Qty. 5)

Memory Options	Product Code
100 Mpts/ch Memory Option	HDO8KA-L
250 Mpts/ch Memory Option	HDO8KA-XL

Hardware Options	Product Code
16GB to 32GB CPU RAM Upgrade Option. (32 GB of RAM is included standard with HDO8KA-L and HDO8KA-XL memory options)	HDO8KA-16-UPG-32GBRAM
Additional 256GB Removable Solid-state Drive for HDO8000A Series. Includes Windows 7 OS, Teledyne LeCroy oscilloscope software and critical scope operational file duplicates	HDO8k-256GB-SSD-02

General Accessories	Product Code
External GPIB Accessory	USB2-GPIB
Soft Carrying Case	HDO8k-SOFTCASE
Rack Mount Accessory	HDO8k-RACKMOUNT
Accessory Pouch	HDO8k-POUCH
Oscilloscope Cart	OC1021-A
Oscilloscope Cart with additional shelf and drawer	OC1024-A

Local Language Overlays	Product Code
German Front Panel Overlay	HDO8k-FP-GERMAN
French Front Panel Overlay	HDO8k-FP-FRENCH
Italian Front Panel Overlay	HDO8k-FP-ITALIAN
Spanish Front Panel Overlay	HDO8k-FP-SPANISH
Japanese Front Panel Overlay	HDO8k-FP-JAPANESE
Korean Front Panel Overlay	HDO8k-FP-KOREAN
Chinese (Traditional) Front Panel Overlay	HDO8k-FP-CHNES-TR
Chinese (Simplified) Front Panel Overlay	HDO8k-FP-CHNES-SI
Russian Front Panel Overlay	HDO8k-FP-RUSSIAN

Software Options	Product Code
Digital Power Management Analysis Software	HDO8k-DIG-PWR-MGMT
Device and Switch-Mode Power Supply Analysis Option	HDO8k-PWR
Digital Filter Option	HDO8k-DFP2
Serial Data Mask Option	HDO8k-SDM
Clock and Clock-Data Timing Jitter Analysis Package	HDO8k-JITKIT
Advanced Customization Option	HDO8k-XDEV
EMC Pulse Parameter Software Package	HDO8k-EMC
VectorLinQ Vector Signal Analysis	HDO8k-VECTORLINQ

Product Description	Product Code
Serial Data Options	
MIL-STD-1553 Trigger and Decode Option	HDO8K-1553 TD
MIL-STD-1553 Trigger, Decode, Measure/Graph, and Eye Diagram Option	HDO8K-1553 TDME
ARINC 429 Bus Symbolic Decode Option	HDO8K-ARINC429BUS DSYMBOLIC
ARINC 429 Bus Symbolic Decode, Measure/Graph, and Eye Diagram Option	HDO8K-ARINC429BUS DME SYMBOLIC
AudioBus Trigger and Decode Option	HDO8K-Audiobus TD
AudioBus trigger, decode, and graph Option	HDO8K-Audiobus TDG
CAN FD Trigger and Decode Option	HDO8K-CAN FDBUS TD
CAN FD Trigger, Decode, Measure/Graph, and Eye Diagram Option	HDO8K-CAN FDBUS TDME
CAN FD Symbolic Trigger, Decode, and Measure/Graph, and Eye Diagram Option	HDO8K-CAN FDBUS TDME SYMBOLIC
CAN Trigger & Decode Option	HDO8K-CANBUS TD
CAN Trigger, Decode, Measure/Graph, and Eye Diagram Option	HDO8K-CANBUS TDME
CAN Symbolic Trigger, Decode, and Measure/Graph, and Eye Diagram Option	HDO8K-CANBUS TDME SYMBOLIC
DigRF 3G Bus Decode Option	HDO8K-DigRF3Gbus D
DigRF V4 Bus Decode Option	HDO8K-DigRFV4bus D
MIPI D-PHY CSI-2, DSI Bus Decode Option	HDO8K-DPHYbus D
MIPI D-PHY CSI-2, DSI Bus Decode and Physical Layer Test Option	HDO8K-DPHYbus DP
ENET Bus Decode Option	HDO8K-ENETbus D
Bundle: Includes I2C, SPI, UART-RS232 Trigger and Decode Option	HDO8K-EMB TD
Bundle: Incl. I2C, SPI, UART-RS232 Trigger, Decode, Measure/Graph, and Eye Diagram Option	HDO8K-EMB TDME
FlexRay Trigger and Decode Option	HDO8K-FLEXRAYBUS TD
FlexRay Trigger, Decode, Measure/Graph and Physical Layer Option	HDO8K-FLEXRAYBUS TDMP
I2C Trigger and Decode Option	HDO8K-I2CBUS TD
I2C Trigger, Decode, Measure/Graph, and Eye Diagram Option	HDO8K-I2CBUS TDME
LIN Trigger and Decode Option	HDO8K-LINBUS TD
LIN Trigger, Decode, Measure/Graph, and Eye Diagram Option	HDO8K-LINBUS TDME
Manchester Bus Decode Option	HDO8K-MANCHESTERbus D
MDIO Decode Option	HDO8K-MDIObus D
NRZ Bus Decode Option	HDO8K-NRZbus D
SENT Bus Decode Option	HDO8K-SENTbus D
SpaceWire Decode Option	HDO8K-SPACEWIREbus D
SPI Trigger and Decode Option	HDO8K-SPIBUS TD
SPI Trigger, Decode, Measure/Graph, and Eye Diagram Option	HDO8K-SPIBUS TDME
SPMI Decode Option	HDO8K-SPMIbus D
UART-RS232 Trigger and Decode Option	HDO8K-UART-RS232BUS TD
UART-RS232 Trigger, Decode, Measure/Graph, and Eye Diagram Option	HDO8K-UART-RS232BUS TDME
USB 2.0 HSIC Decode Option	HDO8K-USB2-HSICbus D
USB 2.0 Trigger and Decode Option	HDO8K-USB2bus TD
USB 2.0 Trigger, Decode, Measure/Graph, and Eye Diagram Option	HDO8K-USB2BUS TDME

ORDERING INFORMATION



Product Description	Product Code
Probes and Amplifiers	
Additional 500 MHz Passive Probe, 10:1, 10 M Ω , 2.5 mm tip	PP023
Set of 2 PP023	PP023-2
Additional 500 MHz Passive Probe, 10:1, 10 M Ω , 5 mm tip	PP026
Set of 2 PP026	PP026-2
Power/Voltage Rail Probe. 4 GHz bandwidth, 1.2x attenuation, \pm 30V offset, \pm 800mV	RP4030
Browser for use with RP4030	RP4000-BROWSER
1kV, 120 MHz High Voltage Differential Probe	HVD3106
1kV, 80 MHz High Voltage Differential Probe with 6m cable	HVD3106-6M
1kV, 120 MHz High Voltage Differential Probe without tip Accessories	HVD3106-NOACC
1kV, 25 MHz High Voltage Differential Probe	HVD3102
1kV, 25 MHz High Voltage Differential Probe without tip Accessories	HVD3102-NOACC
2kV, 120 MHz High Voltage Differential Probe	HVD3206
2kV, 80 MHz High Voltage Differential Probe with 6m cable	HVD3206-6M
6kV, 100 MHz High Voltage Differential Probe	HVD3605
High Voltage Fiber Optic Probe, 60 MHz (requires accessory tip)	HVFO103
\pm 1V (1x) Tip Accessory for HVFO103	HVFO100-1X-TIP
\pm 5V (5x) Tip Accessory for HVFO103	HVFO100-5X-TIP
\pm 20V (20x) Tip Accessory for HVFO103	HVFO100-20X-TIP
30 A; 100 MHz Current Probe – AC/DC; 30 A _{rms} ; 50 A _{peak} Pulse	CP031
30 A; 100 MHz High Sensitivity Current Probe – AC/DC; 30 A _{rms} ; 50 A _{peak} Pulse	CP031A
30 A; 50 MHz Current Probe – AC/DC; 30 A _{rms} ; 50 A _{peak} Pulse	CP030
30A, 50 MHz Current Probe with 3 meter cable	CP030-3M
30 A; 80 MHz High Sensitivity Current Probe – AC/DC; 30 A _{rms} ; 50 A _{peak} Pulse	CP030A
150 A; 10 MHz Current Probe – AC/DC; 150 A _{rms} ; 500 A _{peak} Pulse	CP150
150 A, 5 MHz Current Probe with 6 meter cable	CP150-6M
500 A; 2 MHz Current Probe – AC/DC; 500 A _{rms} ; 700 A _{peak} Pulse	CP500
Deskew Calibration Source for CP031, CP030 and HV Differential Probes	DCS015

Product Description	Product Code
Probes and Amplifiers (cont'd)	
500 MHz, 3.1 pF, 1 M Ω Active Differential Probe, \pm 40 V, with 10X Gain, 42V common-mode	AP033
200 MHz, 3.5 pF, 1 M Ω Active Differential Probe, \pm 20 V, 60V common-mode	ZD200
500 MHz, 1.0 pF, 1 M Ω Active Differential Probe, \pm 8 V, 10V common-mode	ZD500
1 GHz, 1.0 pF, 1 M Ω Active Differential Probe, \pm 8 V, 10V common-mode	ZD1000
1.5 GHz, 1.0 pF, 1 M Ω Active Differential Probe, \pm 8 V, 10V common-mode	ZD1500
1 GHz, 0.9 pF, 1 M Ω High Impedance Active Probe	ZS1000
Set of 4 ZS1000	ZS1000-QUADPAK
1.5 GHz, 0.9 pF, 1 M Ω High Impedance Active Probe	ZS1500
Set of 4 ZS1500	ZS1500-QUADPAK
1 Ch, 100 MHz Differential Amplifier with Precision Voltage Source	DA1855A
100:1 or 10:1 Selectable, 250 MHz Passive Diff. Probe Pair	DXC100A
1:1, 50 MHz Passive Differential Probe Pair	DXC200
100:1, 250 MHz, 2.5kV High Voltage Probe Pair	DXC5100
10x, 1 M Ω Passive Attenuator for DXC Series Probes	DA101
400 MHz, 1kV Vrms High-Voltage Passive Probe	HVP120
100:1 400 MHz 50 M Ω 4 kV High-voltage Probe	PPE4KV
1000:1 400 MHz 50 M Ω 5 kV High-voltage Probe	PPE5KV
1000:1 400 MHz 50 M Ω 6 kV High-voltage Probe	PPE6KV
TekProbe to ProBus Probe Adapter	TPA10
Set of 4 TPA10	TPA10-QUADPAK
Programmable ProBus Current Adapter	CA10
Set of 4 CA10	CA10-QUADPAK

Customer Service

Teledyne LeCroy oscilloscopes and probes are designed, built, and tested to ensure high reliability. In the unlikely event you experience difficulties, our digital oscilloscopes are fully warranted for three years and our probes are warranted for one year. This warranty includes:

- No charge for return shipping
- Long-term 7-year support
- Upgrade to latest software at no charge



1-800-5-LeCroy
teledynelecroy.com

**Local sales offices are located throughout the world.
Visit our website to find the most convenient location.**